

HOW TO MAKE A FACE MASK

PLEASE READ THE FOLLOWING NOTES:
"WHAT TO KNOW ABOUT YOUR HOMEMADE MASKS"

- THIS FITTED FACE MASK PATTERN INCLUDES "FILTER POCKET FLAPS" TO HOLD REMOVEABLE MATERIAL.
- FABRIC USED TO MAKE MASKS SHOULD BE BREATHABLE AND PRE-WASHED.
- WASH THE MASK BETWEEN EACH USE. NEVER REUSE THE REMOVABLE FILTERS.
- THIS REUSABLE MASK IS MOST EFFECTIVE FOR SHORT TERM USE (3 HOUR MAXIMUM).
- ALWAYS PUT ON AND REMOVE THE MASK WITH CLEAN HANDS AND BY THE EAR/HEAD STRAPS.
- THIS HOMEMADE MASK HAS NOT BEEN TESTED OR APPROVED BY ANY HEALTH ORGANIZATIONS AND IS NOT A MEDICAL GRADE MASK.

MATERIALS NEEDED:

- 0.25 METER OF FABRIC (100% COTTON, MEDIUM TO HEAVY WEIGHT)
- 20" ELASTIC (OR TWILL, RIBBON, BINDING TAPE)
- NOSE WIRE/ ADJUSTABLE METAL WIRE (OPTIONAL) - NOT SHOWN IN VIDEO
- FILTRATION LAYER (OPTIONAL)

BASIC SEWING TOOLS

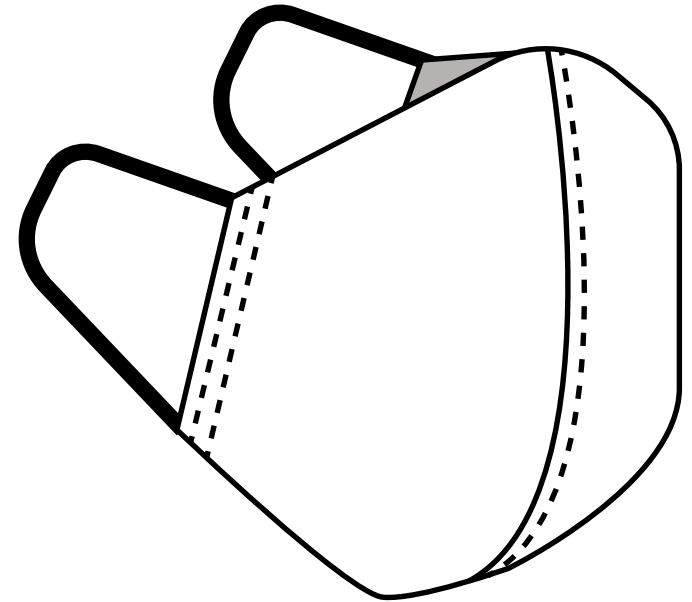

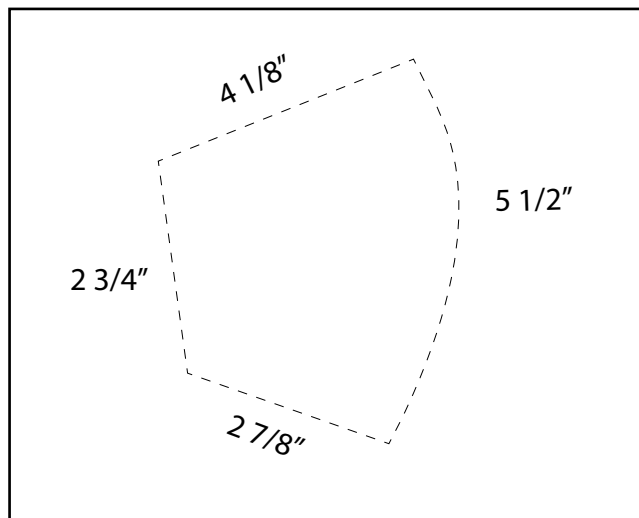
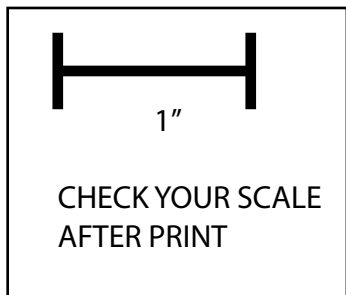

MEASUREMENTS ABOVE DO NOT INCLUDE SEAM ALLOWANCES.

YOU MAY WANT TO ADJUST THE MASK'S LENGTH OR WIDTH TO FIT YOUR FACE,

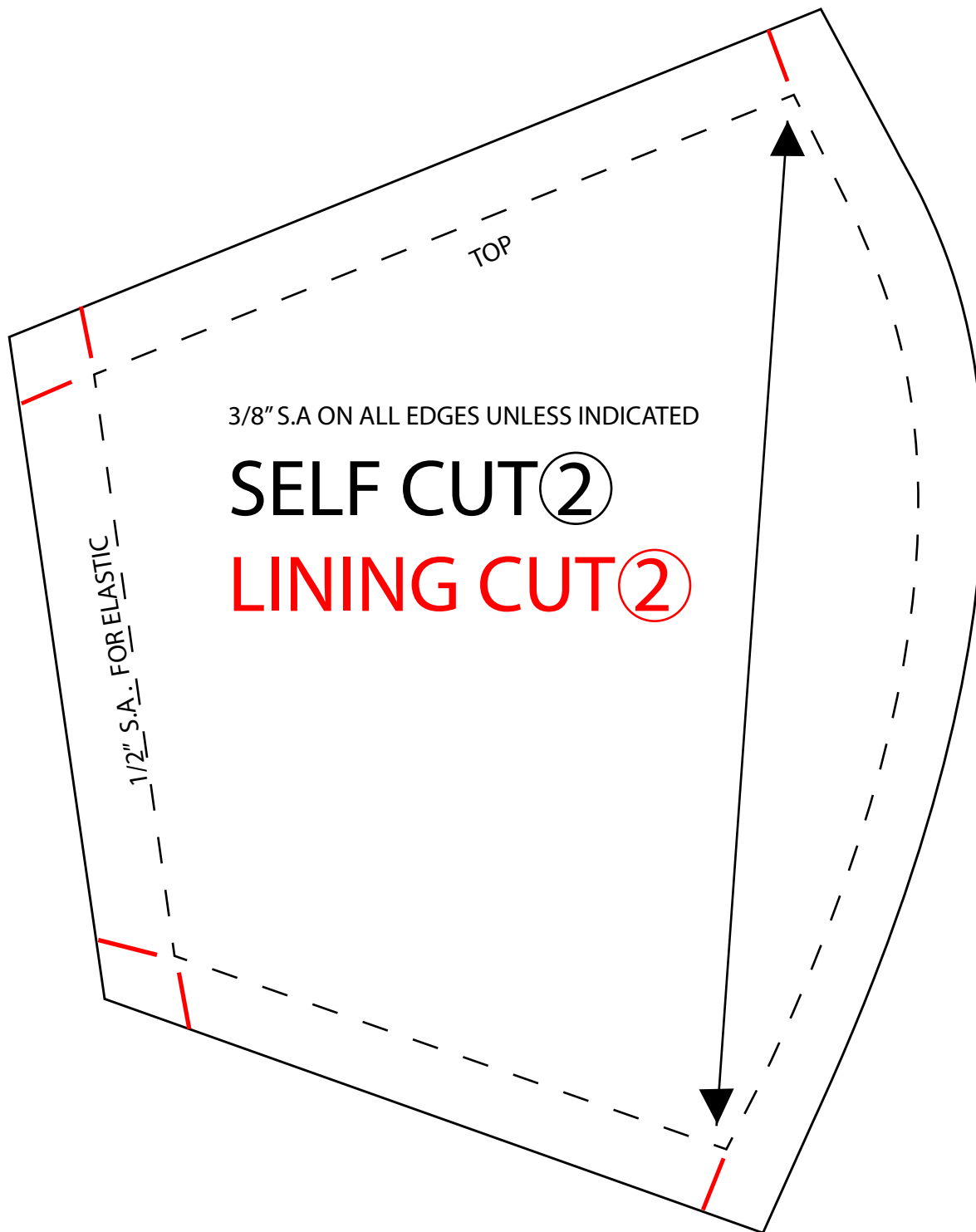

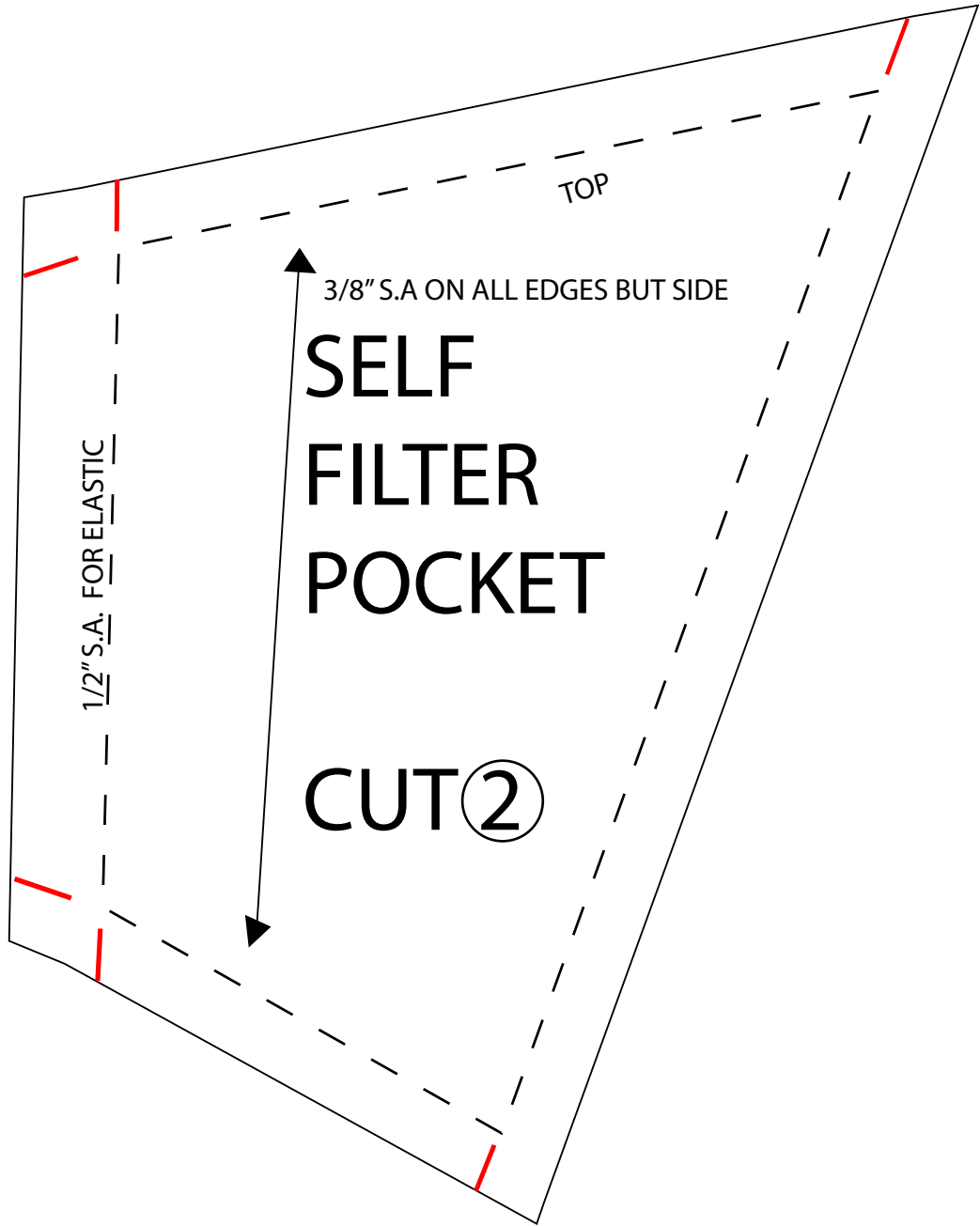
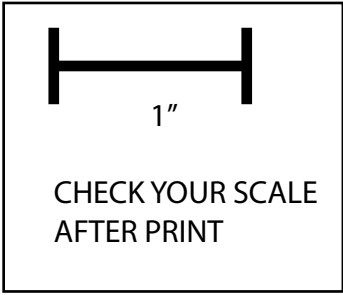

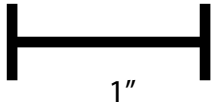

CHECK YOUR SCALE
AFTER PRINT

